



SUBMERSIBLE CORROSION-RESISTANT PUMPS



Submersible Corrosion-Resistant Pumps

Tsurumi Submersible corrosion-resistant pumps are made of stainless steel (304 or 316) and titanium. Because these materials are used, the pumps can handle chemical fluids of low pH value (e.g., corrosive acidic fluid), as well as seawater.

The corrosion-resistant pumps use highly corrosion-resistant materials for all parts that are exposed to fluids, including the impeller, casing, motor frame, outer cover, strainer stand, bend, flange and sealing parts.

Tsurumi puts particular effort into developing submersible pumps made of 316 stainless steel casting. In recent years, polluted water and runoff from mines and quarries have been cited as social problems in many countries, to the point that demand for pumps that can handle these fluids has been increasing year by year. In fact, more than 40% of the runoff from mines is strongly acidic with a pH value of less than 4. To meet this application, Tsurumi has aggressively continued development of all stainless steel pumps that are made of 316 stainless steel casting.

Because they are made of stainless steel casting, the pumps are resistant to wastewater containing abrasive substances, as well as corrosive fluids. That is, these pumps deliver the durability needed in harsh fields where pumps made of aluminium, stainless steel and cast iron suffer damage in a matter of weeks, if not days. More specifically, principal parts of the LH/LH-W-14 and SFQ series are made of 316 stainless steel casting, which considerably improves product reliability in comparison with stainless steel in applications involving heavy-duty work. Therefore, Tsurumi's stainless steel pumps can serve in harsh environments such as mines and quarries, as well as in chemical plants and wastewater treatment plants, thus covering a wide range of applications.

Furthermore, Tsurumi offers seawater pumps that use titanium for parts exposed to fluids. The combination of titanium and resin enables a lightweight compact design that is the most suitable for handling seawater.

Tsurumi continues its research so as to handle a variety of fluids.



Selection Table

		Corrosive Liquids				Seawater
		LH-14	LH-W-14	SQ2	SFQ	TM
Discharge Bore	mm	100 - 200	80	40 · 50	50 · 80	40 - 80
Motor Output	kW	22 - 110	11 · 22	0.25 - 0.75	0.4 - 11	0.25 - 3.7
Discharge Design	Top Discharge, Flow-thru	●	●	●		
	Side Discharge				●	●
Major Wetted Parts		316 Stainless Steel Casting	316 Stainless Steel Casting	304/316 Stainless Steel and Resin	316 Stainless Steel Casting	Titanium and Resin
Rubber Parts		FPM (FKM)	FPM (FKM)	Nitrile Butadiene Rubber	FPM (FKM)	Nitrile Butadiene Rubber
Automatic Operation				● (Single-phase only)		●
Guide Rail Fitting System					●	
Page No.		7 - 8		9 - 10		11 - 12

In addition to the target models, Tsurumi's standard material pumps can be made of stainless steel as an option. To request this option, contact your dealer.

pH Values and Corrosion Resistance of Tsurumi Pumps

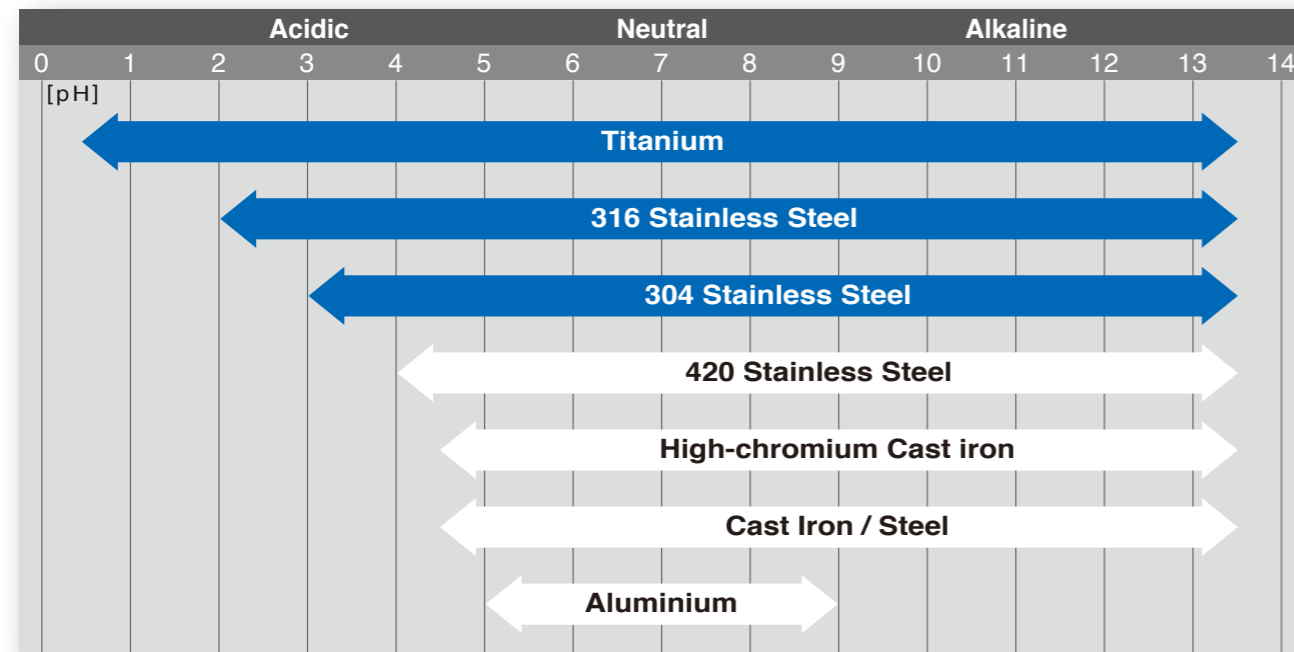

The above data is a rough indication for sulfuric acid (H₂SO₄) and sodium hydroxide (NaOH). Metals are affected by the type of acid/alkali, seal material, painting and abrasive environment.

Special Rubber Parts Made of FPM (FKM) (LH/LH-W-14 & SFQ series only)

Rubber parts of the mechanical seal, oil seal, O-ring and packings are made of FPM (FKM) which provides higher resistance to heat and chemicals.

Automatic Operation (SQ2 & TM series only)

The automatic model only operates when sufficient water is present. It not only reduces power consumption but also extends the life of wear parts of the pump as it eliminates dry-running that causes early wear-out. The float type automatic model has an integral control circuit and two float switches that operate at a low voltage.



Guide Rail Fitting System (SFQ-series only)

The guide rail fitting system connects the pump to and from the piping easily just by lowering and hoisting the pump, allowing easy maintenance and inspection without the need to enter the sump.



Accessories

- Duckfoot Bend
- Guide Support
- Guide Hook
- Lifting Chain 5m (with Shackles)
- JIS 10kg/cm² Flange

Model Number Designation

LH-14 / LH-W-14 series

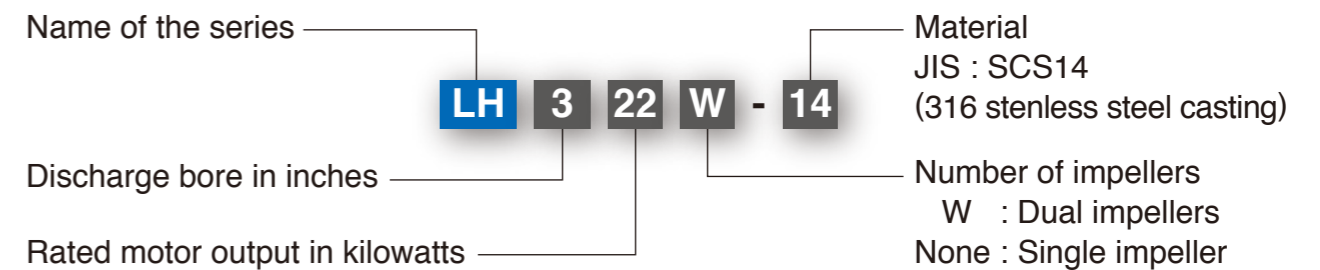

SQ2 / SFQ / TM series

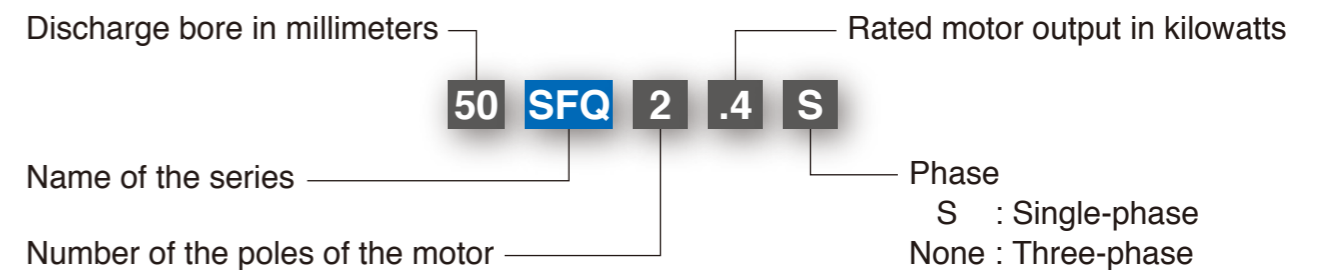

Corrosion-Resistant Material

Parts that are exposed to fluids are made of a highly corrosion-resistant material that protects the pump against corrosion.

LH-14 / LH-W-14 / SFQ series: 316 Stainless Steel Casting
 SQ2-series: 304/316 Stainless Steel and Resin
 TM-series: Titanium and Resin

Top Discharge, Flow-thru Design (LH-14 / LH-W-14 / SQ2 series)

This design provides maximum motor cooling efficiency allowing continuous operation at low water levels and extended dry-run capability, and also allows the shape of the pump to be cylindrical and slim for installation in a well casing for deep well dewatering.

Model
LH8110-14

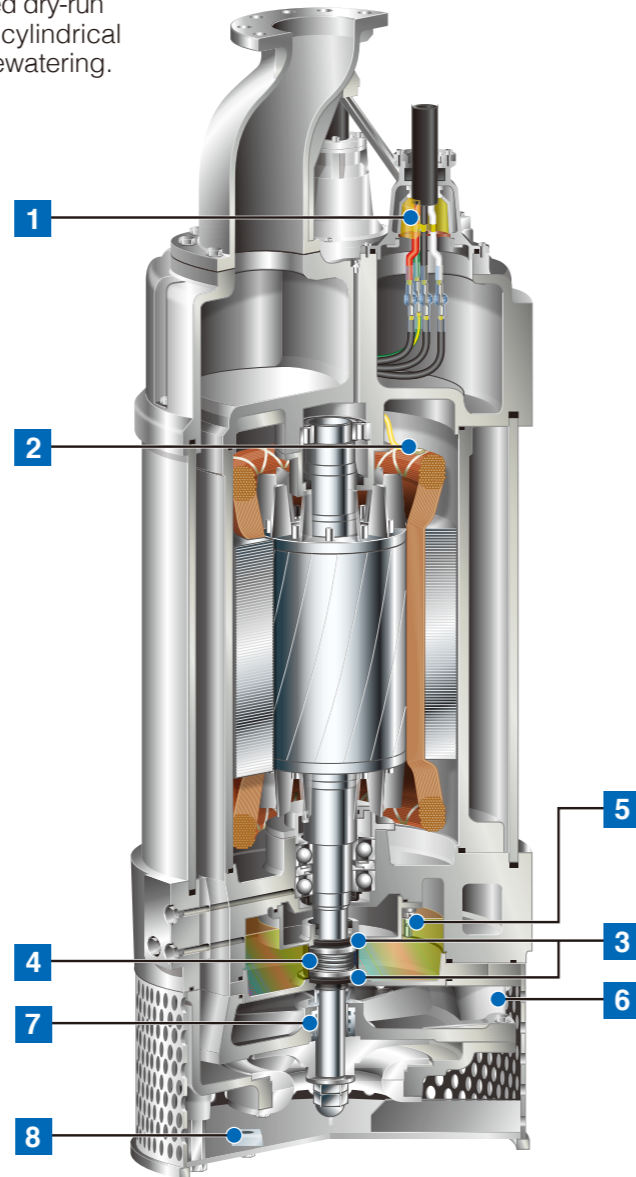

Side Discharge Design (SFQ / TM series)

The pump has a pump casing that facilitates smoother passage of foreign objects in the pumped liquid. It is a simple and practical design that facilitates inspection and repair work.

Model
50TM2.4S

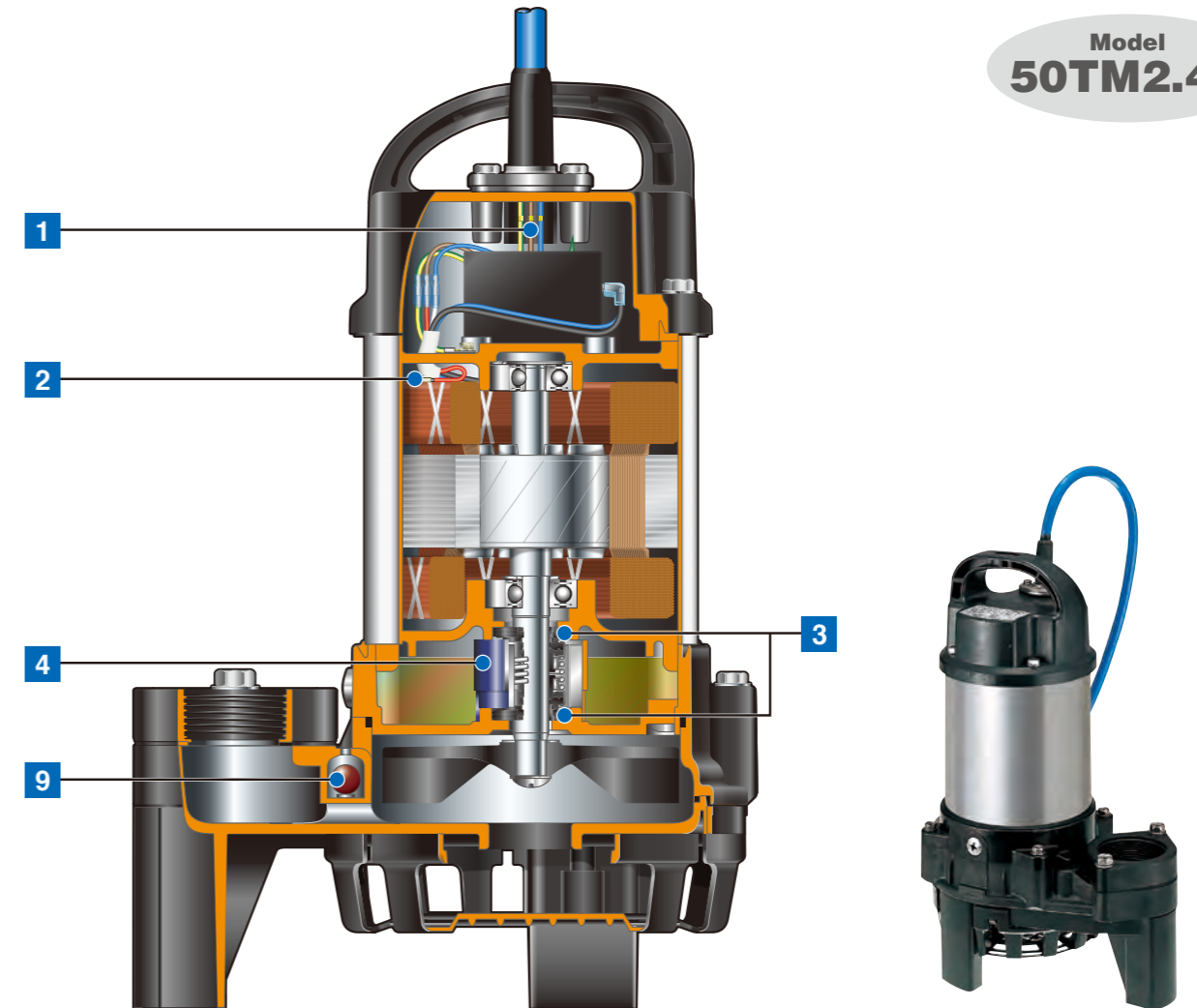

1 Anti-wicking Cable Entry

Prevents water incursion due to capillary action should the cable sheath be damaged or the end of cable submerged. Also prevents moist air from infiltrating the motor housing and condensation from forming inside the housing due to temperature differences between the housing and outside air.

2 Motor Protector

MTP

Single-phase:
 Detects excess heat, therefore, protecting the pump against overheating and dry-running.

Three-phase:
 React to excessive heat caused by dry-running. The bimetal strip opens to cause the control panel to shut the power supply.

CTP

Directly cuts the motor circuit if excessive heat builds up or overcurrent occurs in the motor.

3 Dual Inside Mechanical Seals with Silicon Carbide Face

Isolated in the oil chamber where a clean, non-corrosive and abrasion-free lubricating environment is maintained. Compared with the water-cooled outside mechanical seal, it reduces the risk of failure caused by dry-heating and adhering matter. The Silicon carbide provides 5 times higher corrosion, wear and heat resistance than the tungsten carbide. Rubber parts are made of NBR or FPM (FKM) which provides higher resistance to heat and chemicals.

4 Oil Lifter

Provides lubrication and cooling of the seal faces down to 1/3 of normal oil level, thus maintaining a stable shaft sealing effect and prolonging seal life longer. The Oil Lifter is Tsurumi original design.

5 Leakage Sensor (LH6110-14 and LH8110-14 only)

Detects flooding into the oil chamber that may occur in a worst case scenario. When flooding is detected, signals are sent to operate the indicator lamps through the external control panel.

6 Seal Pressure Relief Port (LH-14, LH-W-14 and SFQ 5.5kW or over)

Protects the mechanical seal from pump pressure. It also protects the seal face by discharging wear particles.

7 Labyrinth Ring (LH-14 / LH-W-14 series only)

Equipped to provide a better countermeasure against wear caused by high pressure generated in the casing and improve the maintainability.

8 Galvanic Anodes (LH-14 / LH-W-14 series only)

Protect the pump against corrosive potential generated during the drainage of wastewater.

9 Air Release Valve

Fitted on/into the pump casing to prevent the air lock. When air flows through the valve, the ball stays at the bottom, but when the pumped water starts to flow, the ball closes the outlet because of its buoyancy.

LH-14 – Single Impeller, 316 Stainless Steel Casting–

LH-W-14 – Dual Impellers, 316 Stainless Steel Casting–

The LH/LH-W-14 series is a submersible stainless steel casting high head corrosion-resistant pump designed for handling aggressive and corrosive liquids. The all wetted parts are made of 316 stainless steel, enables it to withstand demanding conditions found in construction, aggregate and mining applications. Being the pump cylindrical and slim, it can be installed in a well casing for deep well dewatering. The center flange construction assures a stable installation even if it is fixed by the discharge pipe. The pump incorporates seal pressure relief ports that prevent the pumping pressure from applying to the shaft seal.



Performance Curves

< LH-14 >

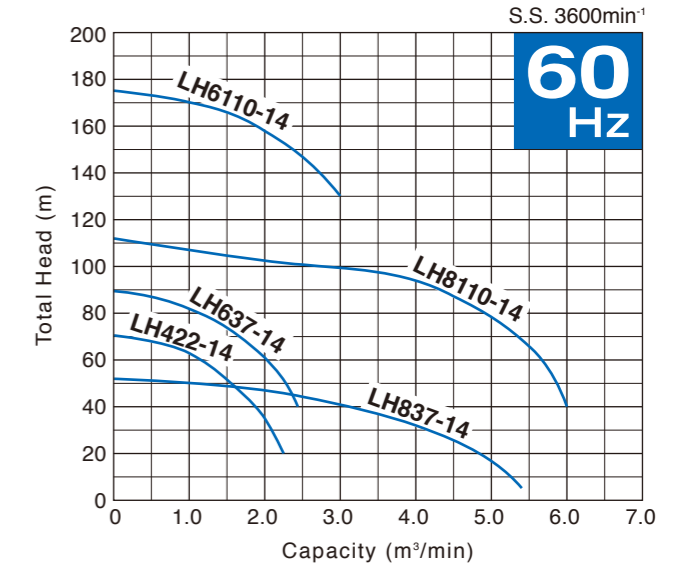
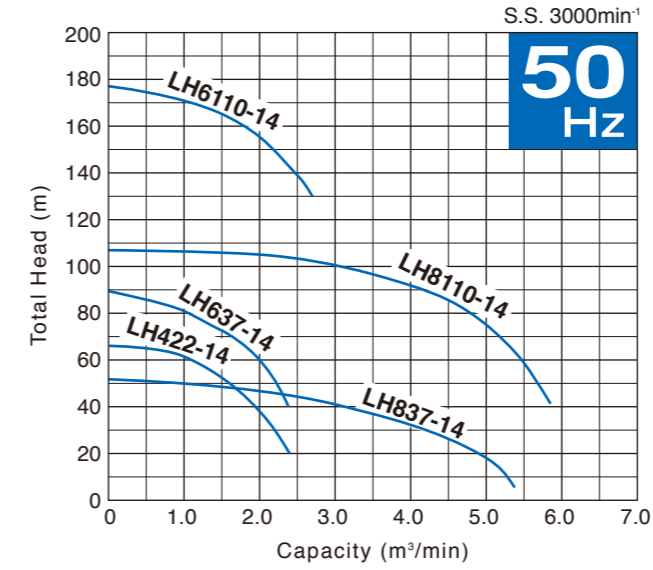

< LH-W-14 >

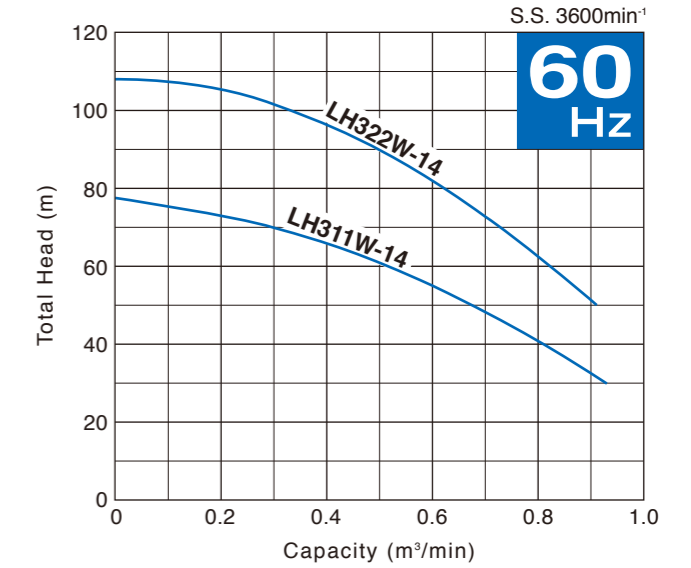
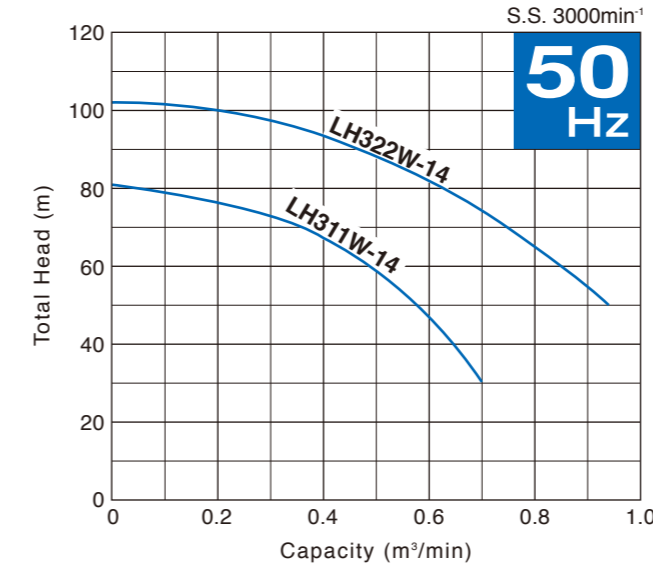

Model	Discharge Bore mm	Motor Output kW	Phase	Starting Method	Solids Passage mm	Dimensions L x H mm	Dry Weight** kg	Cable Length m
LH-14	LH422-14	100	Three	D.O.L.* ¹	6	420 x 1352	370 ^{*3}	10
	LH637-14	150		Star-Delta	6	530 x 1448	540 ^{*3}	10
	LH6110-14	150		Star-Delta	10	592 x 1887	1350 ^{*3}	20
	LH837-14	200		Star-Delta	20	530 x 1488	540 ^{*3}	10
	LH8110-14	200		Star-Delta	20	592 x 1887	1400 ^{*3}	20
LH-W-14	LH311W-14	80	D.O.L.* ¹	8.5	330 x 1184	320 ^{*3}	20	
	LH322W-14	80	D.O.L.* ¹	8.5	330 x 1275	340 ^{*3}	20	

*1 Star-Delta available upon request

*2 Weights excluding cable

*3 Approximate value



SQ2 –304/316 Stainless Steel and Resin– SFQ –316 Stainless Steel Casting–

The SQ2-series is a submersible stainless steel portable corrosion-resistant pump designed for handling corrosive liquids. The major wetted parts are made of 304/316 stainless steel and resin, enables it to withstand demanding conditions found in construction, aggregate and mining applications. Every SQ2 model is slim design enough to be accommodated in an 8-inch pipe. Liquid paraffin is used for the lubricating oil, which enables the application of the SQ2-series to the food or aquaculture industry.

The SFQ-series is a submersible stainless steel casting high head corrosion-resistant pump designed for handling aggressive and corrosive liquids. The all wetted parts are made of 316 stainless steel, enables it to withstand demanding conditions found in construction, aggregate and mining applications. The pump with 5.5kW and above motor incorporates seal pressure relief port that prevents the pumping pressure from applying to the shaft seal.



Model	Discharge Bore mm	Motor Output kW	Phase	Starting Method	Solids Passage 50/60Hz mm	Dimensions L x H mm	Dry Weight* ³ kg	Cable Length m	
SQ2	40SQ2-2.25S	40	0.25	Single	Capacitor Run	6	180 x 366	10.5	5
	40SQ2-2.25	40	0.25	Three	D.O.L.	6	180 x 366	10.5	5
	50SQ2-2.4S	50	0.4	Single	Capacitor Run	6	180 x 366	10.5	5
	50SQ2-2.4	50	0.4	Three	D.O.L.	6	180 x 366	10.5	5
	50SQ2-2.75	50	0.75	Three	D.O.L.	6	180 x 386	12	5
SFQ	50SFQ2.4S	50	0.4	Single	Capacitor Start	6	252 x 427	21	5
	50SFQ2.4	50	0.4	Three	D.O.L.	6	252 x 398	20	6
	50SFQ2.75	50	0.75	Three	D.O.L.	6	252 x 398	22	6
	80SFQ21.5	80	1.5	Three	D.O.L.	6	329 x 484	36	6
	80SFQ23.7	80	3.7	Three	D.O.L.	15	359 x 542	52	6
	80SFQ25.5* ¹	80	5.5	Three	D.O.L.	18	635 x 844	124	8
	80SFQ27.5* ¹	80	7.5	Three	D.O.L.	23 / 20	635 x 844	123	8
	80SFQ211* ¹	80	11	Three	D.O.L. / Star-Delta* ²	23	635 x 892	143	8

*¹ The SFQ 5.5-11kW models are selectable from the strainer stand type or the pump stand type.

*² D.O.L. with miniature thermal protectors for the strainer stand type. Star-Delta for the pump stand type.

*³ Weights excluding cable

- Automatic model of the SQ2-series is available in single-phase.
- Guide rail fitting model is available in 5.5kW and above.
- As an option, the SFQ 1.5-3.7kW models are available for high temperature liquids of up to 80°C.

Performance Curves

Standard and Automatic models have the identical performance.

< SQ2 >

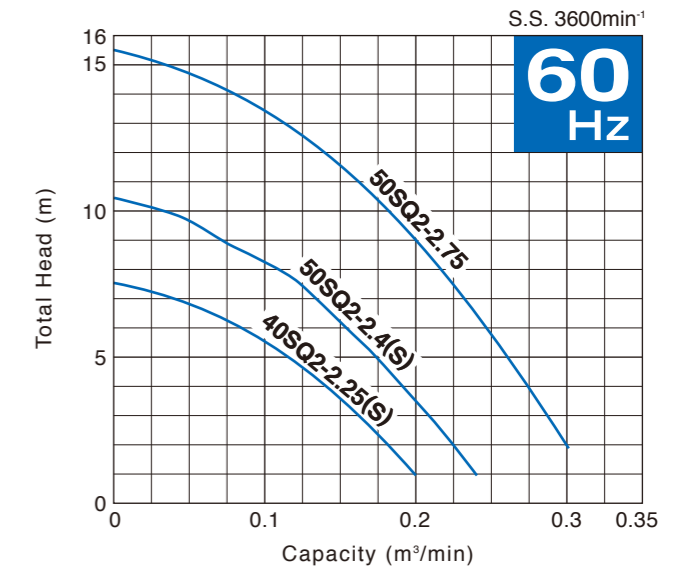
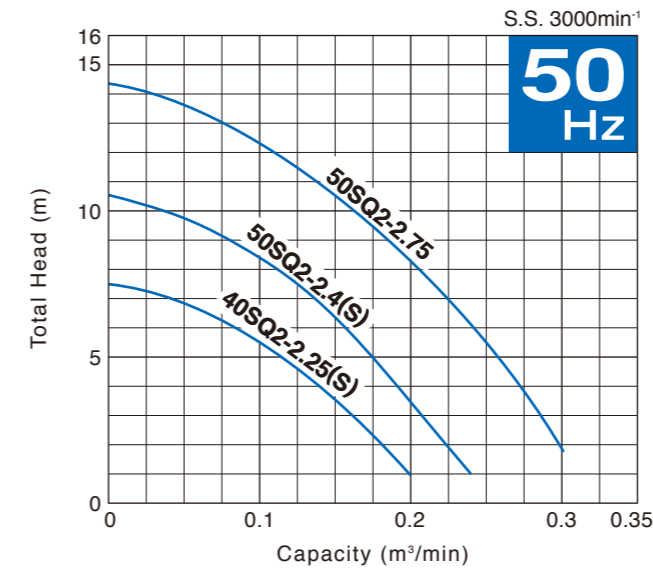

< SFQ >

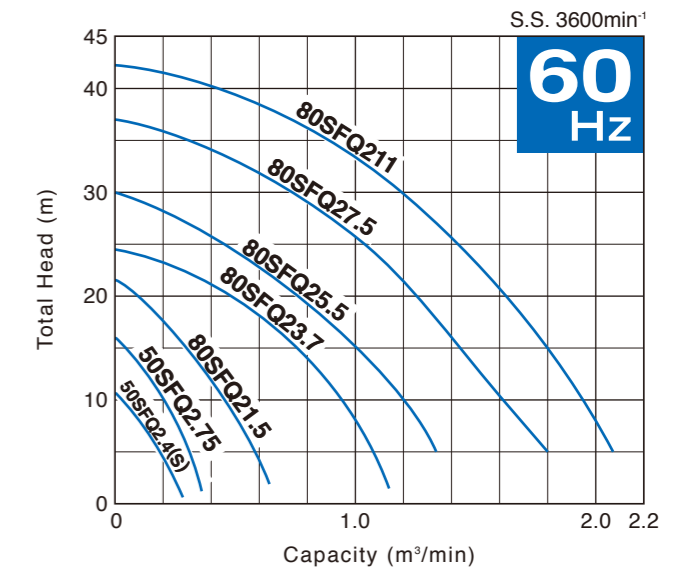
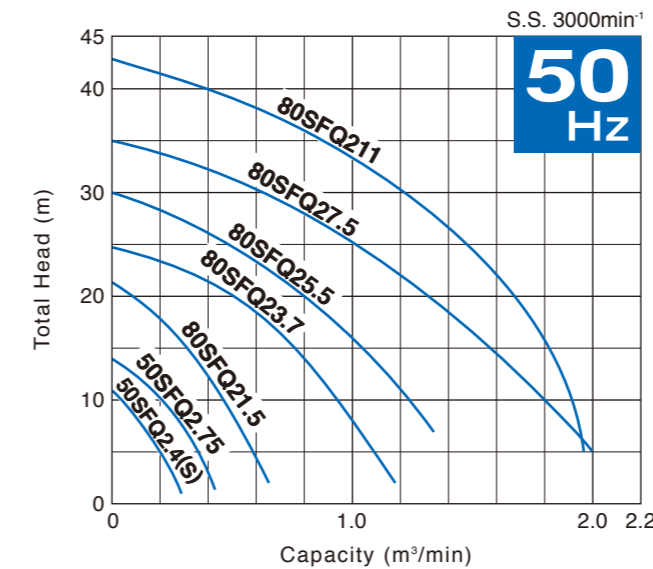

Seawater TM –Titanium and Resin–

The TM-series is a submersible titanium portable pump designed for handling seawater. It is made of titanium and resin. Since titanium has a superb corrosion resistance against seawater, it is suitable for various applications where seawater is used. Liquid paraffin is used for the lubricating oil, which makes it ideal for saltwater aquaculture.



50TM2.4S

50TM21.5

80TM23.7

Model	Discharge Bore mm	Motor Output kW	Phase	Starting Method	Solids Passage mm	Dimensions L x H mm	Dry Weight* kg	Cable Length m	
TM	40TM2.25S	40	0.25	Single	Capacitor Run	10	236 x 360	6.7	5
	40TM2.25	40	0.25	Three	D.O.L.	10	236 x 349	5.7	6
	50TM2.4S	50	0.4	Single	Capacitor Run	10	236 x 360	6.7	5
	50TM2.4	50	0.4	Three	D.O.L.	10	236 x 360	6.6	6
	50TM2.75S	50	0.75	Single	Capacitor Run	10	236 x 380	8.6	5
	50TM2.75	50	0.75	Three	D.O.L.	10	236 x 374	7.8	6
	50TM21.5	50	1.5	Three	D.O.L.	20	295 x 435	14.9	6
	80TM22.2	80	2.2	Three	D.O.L.	20	311 x 559	21	6
80TM23.7	80	3.7	Three	D.O.L.	20	311 x 594	26	6	

* Weights excluding cable
• Automatic model is available.

Performance Curves

Standard and Automatic models have the identical performance.

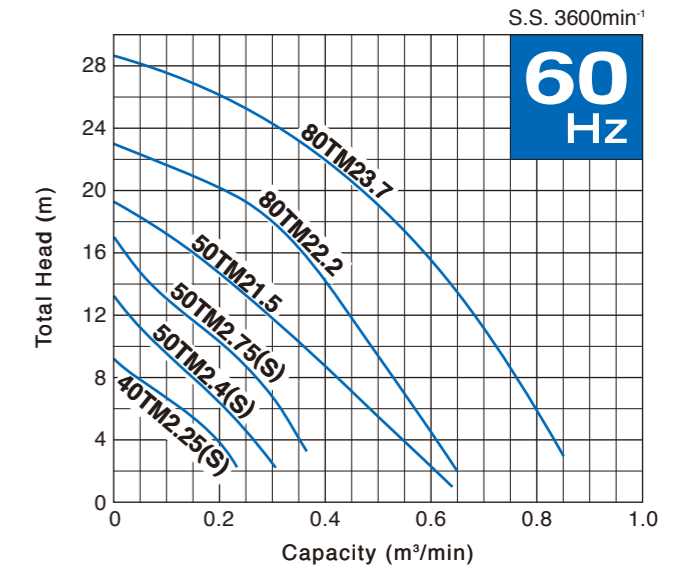
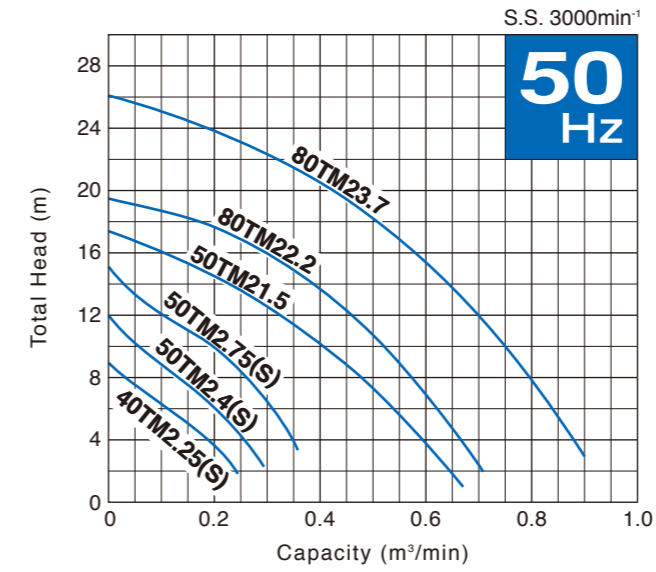

Seawater-Resistant Pumps

Tsurumi's standard pumps can be combined with a seawater-resistant kit (optional) that features a "galvanic anode" and "seawater-resistant special cast iron impeller," for use as submersible seawater-resistant pumps. These pumps have been designed for an expected service life of about two years. (The service life depends on operating conditions.) For details, refer to the Seawater-Resistant Pumps catalog [IB115] or access to our website.



Specifications

		LH-14					LH-W-14		SQ2			SFQ						TM											
		LH422-14	LH637-14	LH6110-14	LH837-14	LH8110-14	LH311W-14	LH322W-14	40SQ2-2.25S	50SQ2-2.4S	50SQ2-2.75	50SFQ2.4S	50SFQ2.75	80SFQ21.5	80SFQ23.7	80SFQ25.5	80SFQ27.5	80SFQ211	40TM2.25S	50TM2.4S	50TM2.75S	50TM21.5	80TM22.2	80TM23.7					
								40SQ2-2.25	50SQ2-2.4		50SFQ2.4							40TM2.25	50TM2.4	50TM2.75									
PUMP	Discharge Bore	mm	100	150		200		80		40	50		50			80			40	50		80							
	Discharge Connection		JIS 10kg/cm ² Flange		JIS 20kg/cm ² Flange	JIS 10kg/cm ² Flange		JIS 20kg/cm ² Flange	Threaded Oval Flange + Hose Coupling			Threaded Oval Flange			Threaded JIS 10kg/cm ² Flange			Threaded Oval Flange											
	Solids Passage 50/60Hz	mm	6		10	20		8.5		6			6			15	18	23/20	23	10		20							
	Impeller		Closed					Closed (Dual)		Vortex			Semi-open						Vortex										
			316 Stainless Steel Casting					Glass-fiber Reinforced PPO			316 Stainless Steel Casting						Glass-fiber Reinforced PPO			Glass-fiber Reinforced PA+ABS									
	Labyrinth Ring		316 Stainless Steel					—			—						—												
	Casing		316 Stainless Steel Casting					Upper: Nitrile Butadiene Rubber Lower: 304 Stainless Steel Casting			316 Stainless Steel Casting						Glass-fiber Reinforced ABS			Glass-fiber Reinforced PA+ABS									
	Shaft Seal		Dual Inside Mechanical Seals (with Oil Lifter)								Dual Inside Mechanical Seals (with Oil Lifter)																		
			Silicon Carbide								Silicon Carbide																		
	Galvanic Anode		Aluminium Alloy			Zinc	Aluminium Alloy	—			—																		
MOTOR	Type	Continuous-duty Rated, Dry-type Induction Motor											Continuous-duty Rated, Dry-type Induction Motor																
	Output	kW	22	37	110	37	110	11	22	0.25	0.4	0.75	0.4	0.75	1.5	3.7	5.5	7.5	11	0.25	0.4	0.75	1.5	2.2	3.7				
	Phase		Three					Single Three		Three			Single Three	Three						Single Three		Three							
	Pole		2											2															
	Insulation		F					E			E	F						E											
	Starting Method		D.O.L.* ²	Star-Delta			D.O.L.* ²		Capacitor Run D.O.L.		D.O.L.			Capacitor Run D.O.L.	D.O.L.						D.O.L. / Star-Delta* ⁴	Capacitor Run D.O.L.			D.O.L.				
	Motor Protector (built-in)		MTP								MTP CTP		CTP			MTP CTP	CTP						MTP	MTP CTP			CTP		
	Leakage Sensor (built-in)		—		Electrode	—		Electrode	—			—																	
	Lubricant	ml	6300* ³	4300* ³	7100* ³	4300* ³	7100* ³	2100* ³		240			125	900	850	2250			240		500	680							
			Turbine Oil (ISO VG32)					Liquid Paraffin (ISO VG32)			Turbine Oil (ISO VG32)						Liquid Paraffin (ISO VG32)												
Frame		316 Stainless Steel Casting					304 Stainless Steel			316 Stainless Steel Casting						Titanium													
Shaft		316 Stainless Steel					304 Stainless Steel			316 Stainless Steel						Titanium													
Cable	m	10	20	10	20		5			5 6	6			8			5 6	6											
		Chloroprene Rubber					PVC			PVC						Chloroprene Rubber						PVC							
Dry Weight* ¹	kg	370* ³	540* ³	1350* ³	540* ³	1400* ³	320* ³	340* ³	10.5	12	21 20	22	36	52	124	123	143	6.7 5.7	8.6 6.6	7.8	14.9	21	26						

*¹ Weights excluding cable *² Star-Delta available upon request *³ Approximate value
*⁴ D.O.L. with miniature thermal protectors for the strainer stand type. Star-Delta for the pump stand type.



Product images and specifications may differ from actual products due to improvements. The OO series and model OO are indicated with our series/model codes in this catalog.

TSURUMI
MANUFACTURING CO., LTD.

Your Dealer



SUPERPUMP
w a t e r p u m p s
www.superpump.co.za

The Superpump logo consists of a stylized blue and grey circular emblem with a water droplet shape. The text "SUPERPUMP" is in a bold, black, sans-serif font, with "water pumps" in a smaller, blue, lowercase sans-serif font below it. The website address "www.superpump.co.za" is in a grey, lowercase sans-serif font at the bottom.