

6GST GLOBAL STANDARD TRASH



Global Pump® Standard Trash pumps are specifically designed to effectively handle a wide range of liquids from water to sewage and sludge that can contain solids and other material.

Global Pump Standard Trash pumps provide a dependable, highly efficient solution. The model 6GST is capable of achieving maximum flows of 3,000 gpm (681 m³/h) and maximum total head of 202' (61.6 m) while handling solids up to 3" (76.2 mm) in diameter.

The standard 6GST is powered by a water-cooled, 4-cylinder diesel engine. Alternative drives are available including natural gas as well as electric motors.

FEATURES

Global Pump's rugged, heavy duty pumps are engineered specifically for portable application

Non-return valve uses only a single moving part to allow with minimal restriction

Standard engine control panel provides preset emergency shutdown protection and allows the addition of automatic level control

Fully guarded coupling

Pump casings are hydrostatically tested to 50 psig (345 kPa) above the peak casing design pressure

Highway trailer with integral fuel cell/chassis, lights, fenders, tie downs, lifting bail, front and rear jacks. Trailer brakes can be offered as required

OPTIONS

Available with a variety of priming systems, including Global's Auto Prime® automatic priming system (compressor-fed venturi priming) or a diaphragm priming system

Mechanical seal with glycol (biodegradable optional) quench allows the pump to start and run dry

Global Pump's Environmental Box separates and silences air exhaust and returns liquid to the pump suction.

Fuel cubes for extended run times and/or remote location as required

Sound attenuated enclosure options

Skid-mounted formats with tie downs, lifting bail, and fork pockets

Hose racks, accessory containers and other custom features available as required

Wide range of suction and discharge fittings including Global Pump's own "QD" Quick Disconnect fittings and accessories

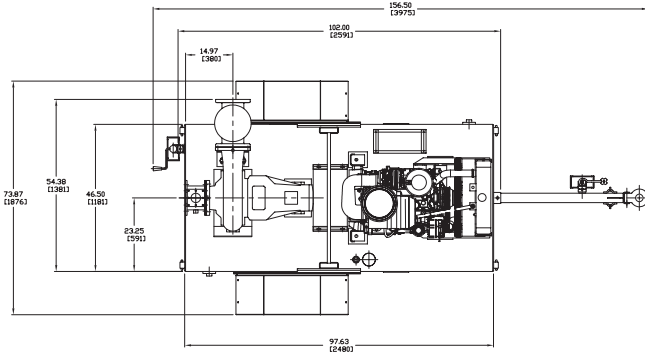
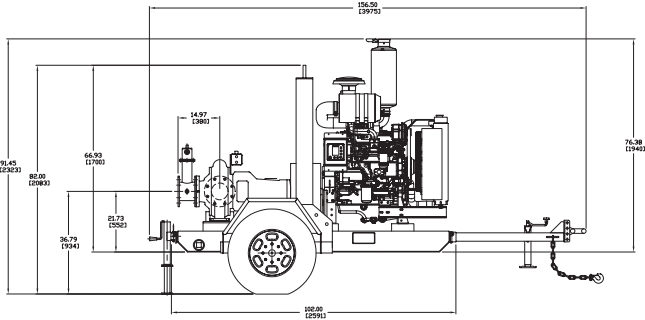

SPECIFICATIONS

Connections	6" (150 mm) ANSI Flanges
Max Pump Speed	2,200 rpm
Max Flow	3,000 gpm (681 m ³ /h)
Max Head	202' (61.6 m)
Max Static Priming Lift	28' (8.5 m)
Temperature Limit	160° F (70° C)
Solids Handling Capability	3" (76.2 mm)
Max Casing Pressure	125 psig (862 kPa)
Fuel Cell	115 gallons (435 liters)
Dry Weight	4,500 lbs

PUMP MATERIAL

Casing	Cast Iron (CD4MCu is an option)
Impeller	Cast Iron (CD4MCu is an option)
Bearing Housing	Cast Iron
Bearing Lubrication	Grease
Shaft/Shaft Sleeve	Steel/Stainless Steel
Seal	Silicon Carbide on Silicon Carbide
Chassis/Fuel Cell	Steel
Non-Return Valve	Nitrile Fitted Cast Iron

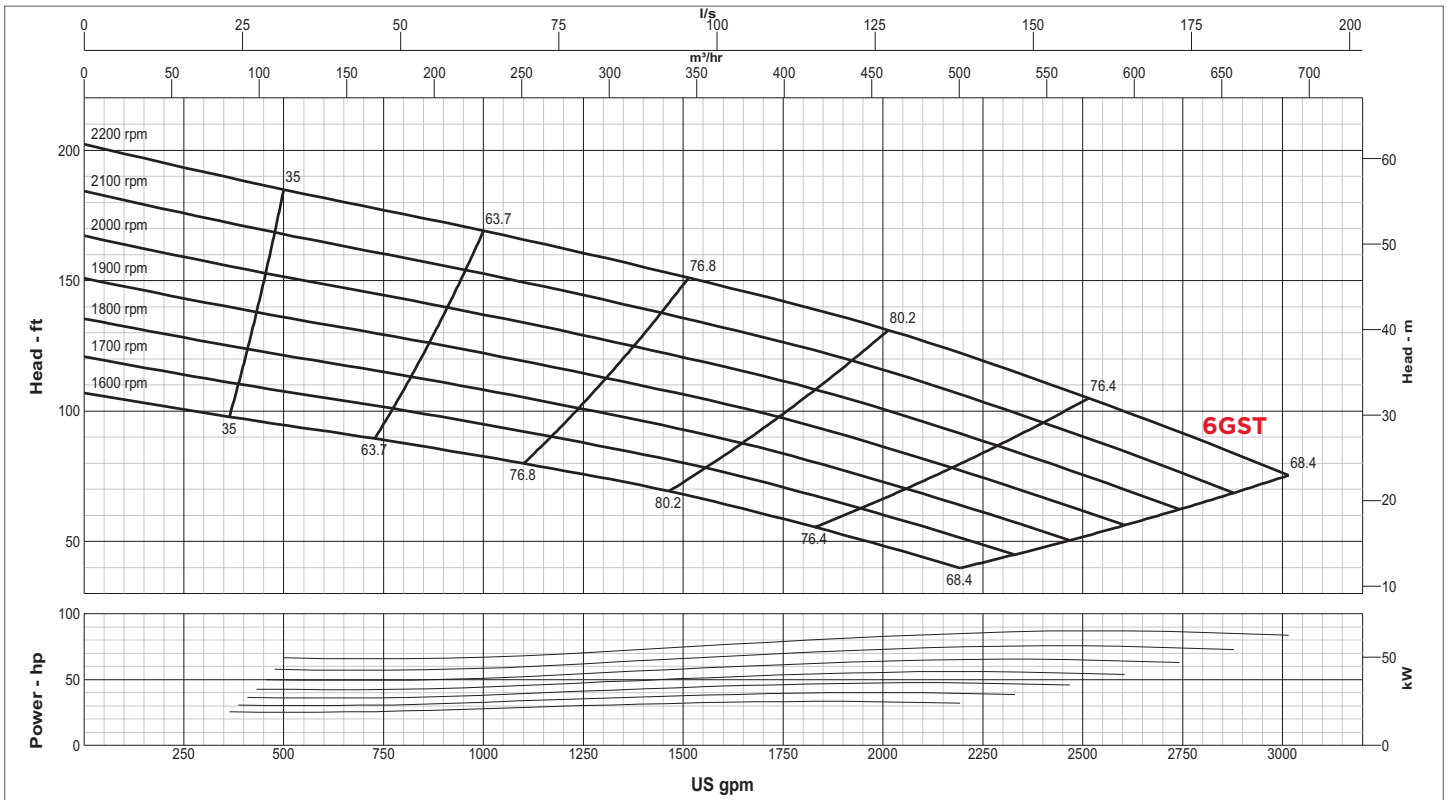

GLOBAL PUMP
 10162 East Coldwater Road, Davison, MI 48423
 Tel: 810.653.4828 Fax: 810.658.0632
1.866.360.PUMP www.globalpump.com